

**MPower  
MODULE** Micro Power Module  
12V Step-Up DC/DC Regulator

**Features**

- Wide Input Voltage Range: **2.4V to 12V DC**
- Output Voltage: **12V**
- Peak Output up to **2000mA**
- Shutdown Pin
- High Efficiency (Typ. 80-90%)
- ±2% Overall Output Voltage Tolerance
- Thermal Limiting Over Current Protection
- Utilizes Low Profile SMT Components
- Small Footprint: 0.8" x 1" (20.32mm x 25.4mm)
- Low Shutdown Current: < 20µA

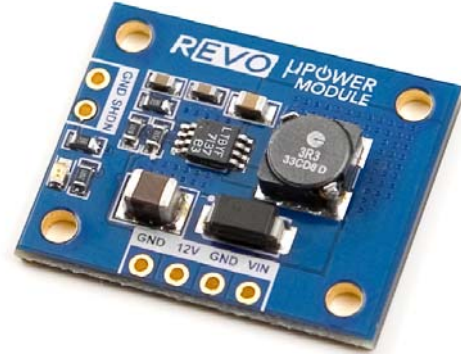

**Applications**

- Commercial Off-the-Shelf Equipment
- On-board Cameras and Video Equipment
- Breadboard Power Supply
- USB to 12V Voltage Converter
- Battery operated devices including applications for single-cell up to 3 cell Lithium Polymers

**Typical Application**

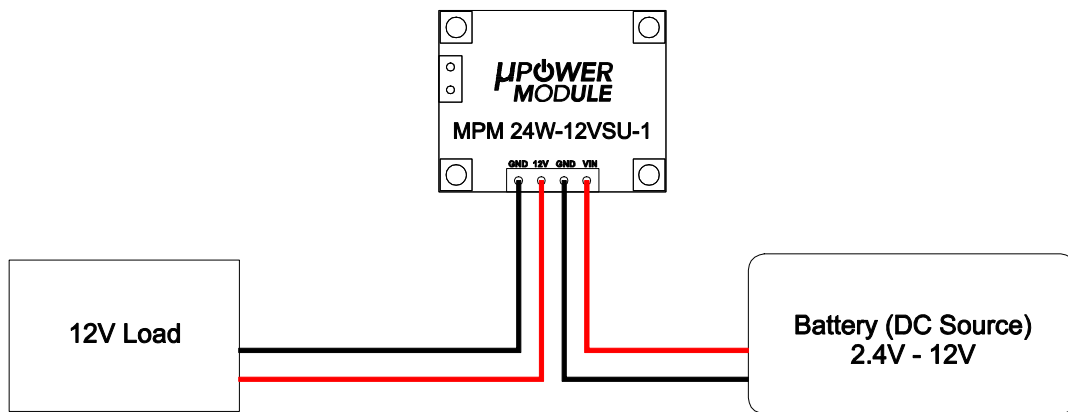

Powering a 12V Load from a DC Battery Source

---

## Part Description

---

### Overview

The Micro Power Module (MPM) 24W-12VSU-1 is a drop-in solution designed to simplify power regulation for projects requiring 12V power supplies. The module provides a low-noise regulated 12V from a wide range of DC sources including single-cell lithium polymer batteries.

The onboard regulator is an efficient step-up regulator topology capable of handling a wide selection of DC input sources. The input voltage can be as low as 2.4V while still providing a clean 12V supply. The shutdown pin can be used to remotely turn off the module.

The MPM is capable of supplying loads up to 2A (some thermal considerations required) depending on the input voltage. Refer to the graphs below for the available supply current at different input voltages. The device can handle higher transient loads but its operating temperature must be taken into consideration. Attaching a heat-sink or active cooling device allows the module to operate at higher load currents while simultaneously increasing operating efficiency.

This module is meant to ease power regulation in projects that utilize a DC power sources operating at or below 12V. As the voltage of the power source drops, this regulator ensures that it maintains its 12V output. This module is ideal in applications where it is necessary to run commercial off the shelf equipment off of DC battery power. The module allows for a single cell lithium polymer battery to supply 12V at a continuous 300mA across its discharge curve, which is useful in operating video, networking equipment, or similar devices requiring a 12V DC. Additionally this module allows two or three cell lithium polymer batteries to power 12V devices with higher load currents.

When supplying input voltages higher than 12V, the output can exceed 12V. When operating at or slightly above 12V with loads greater than 1A, the output voltage may remain at 12V due to the voltage drop across this device; however, it is advised to monitor the output closely when pushing the device beyond its operating limits.

### Design Considerations

Smaller battery packs utilized in today's devices are rarely capable of handling 12V loads. Even in 3 cell lithium polymer battery applications, the typical supply voltage is under 12V. To make it easier to interface to devices requiring 12V, this MPM was designed using a step-up topology that boosts the voltage of the input source and regulates it to 12V. The conversion process efficiency ranges from 70-95% depending on the load and supply voltage. This module was designed to provide wide flexibility, providing operation in a wide range of configurations.

## Part Information

### Absolute Maximum Ratings

Stresses at or above those listed may cause permanent damage to the device. These ratings represent a stress rating only, and functional operation of the devices at or exceeding these conditions is not implied. Exposure to maximum rating conditions for extended periods may reduce the operating life and affect device reliability.

<b>Absolute Maximum Input Voltage:</b>	16V
<b>Operating Temperature Range:</b>	0° C to 100° C
<b>Storage Temperature Range:</b>	-40° C to 125° C
<b>Absolute Maximum Output Current:</b>	2A (2.25A transient <sup>1</sup> )
<b>Board Dimensions:</b>	0.8" x 1" (20.3mm x 25.4mm)
<b>Mounting Screws Holes:</b>	2-56 (Fits Metric M2 & M2.2)

<sup>1</sup> Warning: When operating at high power loads, current spikes may push the inductor into saturation.

### Global DC and I/O Electrical Characteristics

Parameter	Conditions	Min	Typ	Max	Units
VIN Supply Voltage		2.4	-	12	V
Operating Temperature Range		0	-	+85	°C
Output Voltage	Maximum Rated Load and Maximum Operating Temperature	11.76	12	12.24	V
Ripple Voltage (Peak to Peak)		-	-	-	mV
Load Current		25	-	2000	mA

### Pinout Definitions

Name	Type	Description
VIN	Power IN	Connect DC Power Source to this pin (2.4V to 12V)
GND <sup>1</sup>		
12V	Power OUT	Regulated 12V output
SHDN	Digital IN	Places the regulator in low-current shutdown mode

<sup>1</sup> GND is internally connected at multiple pins on this module.

## Performance Limitations and Capabilities

These tests were performed with a stock MPM 24W-12VSU-1 operating at room temperature. No heat sinks were used in these tests. Results may vary depending on operating conditions.

Available Supply Current vs Input Voltage

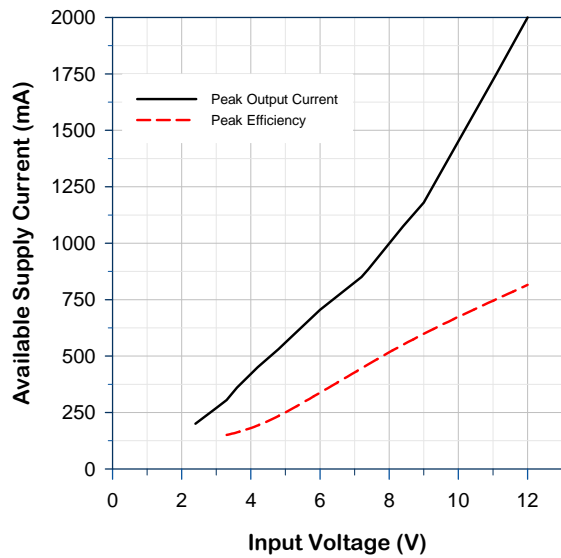

Output Current vs Efficiency

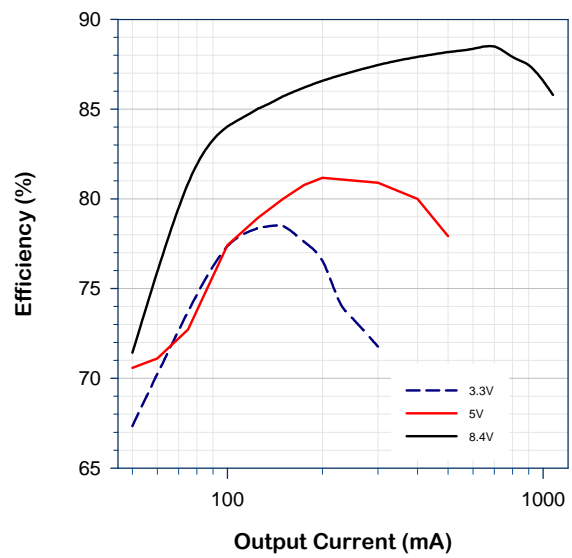

Load Current vs Temperature

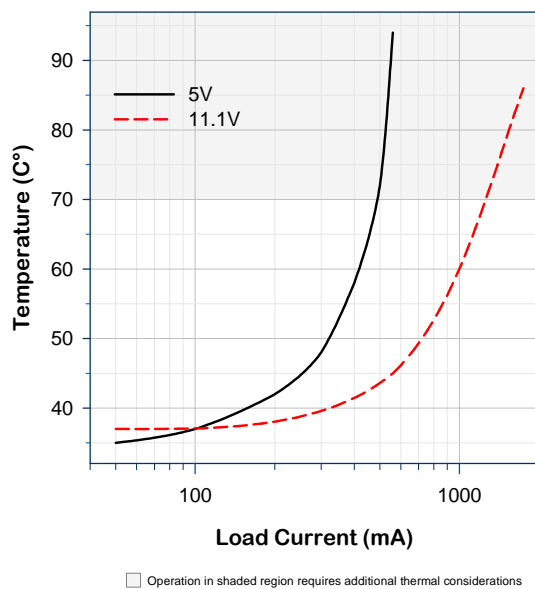

## Output Noise Measurements

Tests results were obtained via a Tektronix TDS 2000 series oscilloscope running a stock MPM 24W-12VSU-1 at room temperature. No heat sinks were used in these tests. Results may vary depending on operating conditions.

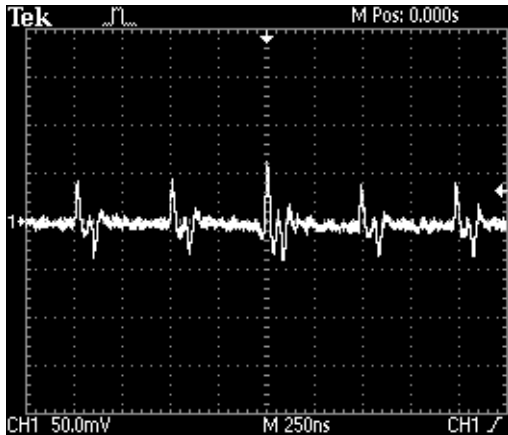

$V_{IN} = 3V$   $I_{OUT} = 200mA$  P-P = 96mV

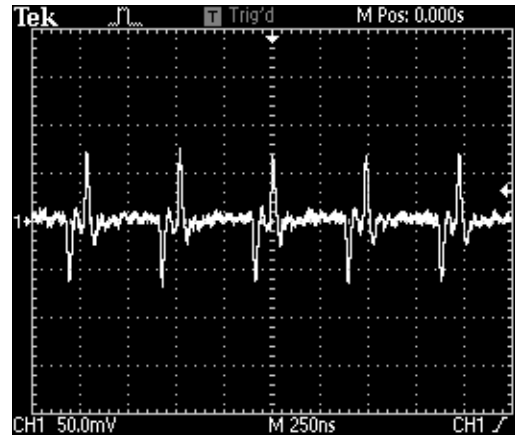

$V_{IN} = 11.1V$   $I_{OUT} = 1750mA$  P-P = 142mV

## Application & Usage Information

### Usage Notes

To use this module, connect any appropriate battery or DC source with a voltage between 2.4V to 12V on VIN and GND. The output line (labeled 12V) will then provide a regulated 12V supply. To power a device, connect the 12V and GND lines to the power terminals of the device. Note that the two ground pins are internally connected and therefore either pin, or both, can be used.

Filter caps are not necessary for operation as they are already mounted internally. However if the load is connected far from the regulator (more than 12 inches) a filter cap may help to reduce noise and improve load performance.

### Current Supply

The regulator's current supply depends on input voltage, supply current, load, and thermal conditions. For example a 500mA output current requires a minimum input voltage of 4.5V. Please refer to the *Available Supply Current vs. Input Voltage* graph above for more information.

High currents require higher input voltages. If too much power is drawn through the regulator, the inductor will saturate and overheat. Thermal controls will limit the power output to protect the device.

It is advisable to attach a heat sink if the device is running hot, placed in an enclosed space, or is attached to a large load.

**Shutdown**

The output can be shut down by grounding the SHDN pin. This places the regulator in a low-quiescent current shutdown mode. This pin can effectively be used as a switch to turn the device on and off.

**Caution: HOT!**

Under load, the module can become very hot. Handle with caution! Exceeding the operating temperature will limit output power as well as the reliability of this device, and continuous operation at these maximums will limit the lifetime of this device. When the thermal threshold is reached, the power output of the device will decrease. To avoid this issue under heavy loads, reduce thermal stress by attaching a heat sink or similar cooling device. This will help to regulate the temperature of the device and maintain higher power outputs.

**Package Description**

**Board Dimensions**

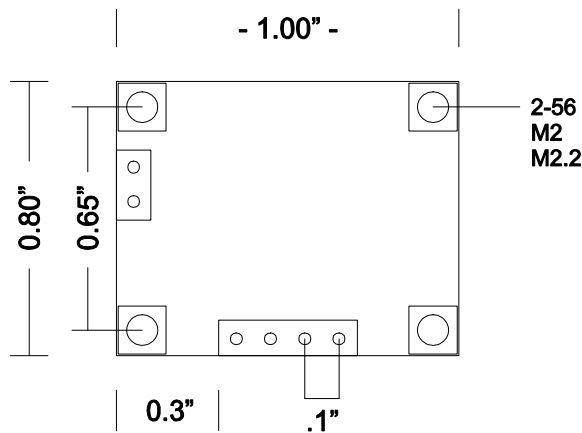

**Board Pinout**

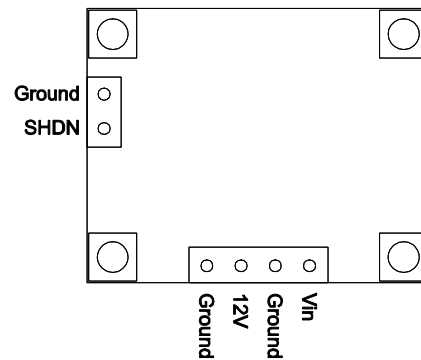

**Actual Size**

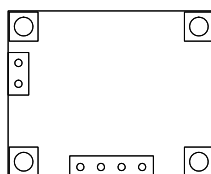

---

## Ordering Information

---

Part No.	Ordering Code	Part Description	Price (Single)
MPM 24W-12VSU-1	MPM24W12VSU1	Micro Power Module 12V Step-up DC/DC Regulator	19.95

**REVO**, REVO, and Revolution Robotics are trademarks of Revolution Robotics, Inc. All other trademarks are the property of their respective owners.

Information furnished by Revolution Robotics Incorporated is believed to be accurate and reliable. However, no responsibility is assumed for its use. Revolution Robotics Incorporated makes no representation that the interconnection of its circuits as described herein will not infringe on existing patent rights.